



# **ENGINEERING STUDIES ATAR COURSE DATA BOOK 2016**

## **Copyright**

© School Curriculum and Standards Authority, 2016

This document – apart from any third party copyright material contained in it – may be freely copied, or communicated on an intranet, for non-commercial purposes in educational institutions, provided that it is not changed and that the School Curriculum and Standards Authority is acknowledged as the copyright owner, and that the Authority's moral rights are not infringed.

Copying or communication for any other purpose can be done only within the terms of the Copyright Act 1968 or with prior written permission of the School Curriculum and Standards Authority. Copying or communication of any third party copyright material can be done only within the terms of the Copyright Act 1968 or with permission of the copyright owners.

Any content in this document that has been derived from the Australian Curriculum may be used under the terms of the Creative Commons Attribution-NonCommercial 3.0 Australia licence.

This document is valid for teaching and examining until 31 December 2016.

**This page has been left blank intentionally**

**SI units**

Quantity	SI unit	
	Name	Symbol
length	metre	m
mass	kilogram	kg
time	second	s
energy, work, quantity of heat	joule	J
power	watt	W
Celsius temperature	degree Celsius	°C
area	square metre	m <sup>2</sup>
volume	cubic metre	m <sup>3</sup>
speed, velocity	metre per second	m s <sup>-1</sup>
mass density	kilogram per cubic metre	kg m <sup>-3</sup>

**Standard prefixes**

Factor	Prefix	Symbol	Factor	Prefix	Symbol
10 <sup>12</sup>	tera	T	10 <sup>-3</sup>	milli	m
10 <sup>9</sup>	giga	G	10 <sup>-6</sup>	micro	μ
10 <sup>6</sup>	mega	M	10 <sup>-9</sup>	nano	n
10 <sup>3</sup>	kilo	k	10 <sup>-12</sup>	pico	p

**Common constant**

Item	Symbol	Value
Ratio of the circumference of a circle to its diameter	$\pi$	3.14159

## CORE CONTENT

### General formulae

Side lengths of a right triangular plane figure	$h^2 = o^2 + a^2$	$h$ is the hypotenuse $o$ is the opposite side $a$ is the adjacent side
Angular relationships of a right triangular figure	$\cos \theta = \frac{a}{h}$ $\sin \theta = \frac{o}{h}$ $\tan \theta = \frac{o}{a}$	$\theta$ is the angle $h$ is the hypotenuse $o$ is the opposite side $a$ is the adjacent side
Perimeter of a circle [ $p$ ]	$p = \pi d$	$d$ is the diameter
Area of a circle [ $A$ ]	$A = \pi r^2$	$r$ is the radius
Surface area of open ended cylinder [ $A$ ]	$A = \pi dh$	$d$ is the diameter $h$ is the height
Volume of a cylinder [ $V$ ]	$V = \pi r^2 h$	$r$ is the radius $h$ is the height
Surface area of a sphere [ $A$ ]	$A = 4\pi r^2$	$r$ is the radius
Volume of a sphere [ $V$ ]	$V = \frac{4}{3}\pi r^3$	$r$ is the radius
Density [ $\rho$ ] of a material	$\rho = \frac{m}{V}$	$m$ is mass $V$ is volume
Energy [ $E$ ]	$E = Pt$	$t$ is the time taken $P$ is the power
Efficiency [ $\eta$ ] %	$\eta\% = \frac{\text{Output}}{\text{Input}} \times 100$	$\eta$ is the efficiency (%)

## Selected material properties

Material	Density kg m <sup>-3</sup>	Elastic (Young's) modulus kN mm <sup>-2</sup>	Ultimate tensile * strength N mm <sup>-2</sup>	Yield stress N mm <sup>-2</sup>	Electrical conductivity Ω <sup>-1</sup> m <sup>-1</sup> × 10 <sup>6</sup>	Thermal conductivity W m <sup>-1</sup> K <sup>-1</sup>
Structural steel	7850	200	470	250	13.0	46
Stainless steel	7600	200	860	502	1.35	16
Cast iron	7200	120	180		10.3	80
Wrought iron	7750	200			10.3	80
Aluminium	2710	70	150	95	37.7	237
Brass	8740	90	190	50	16.7	109
Copper	8930	112	210	70	59.5	401
Zinc	7130	108	200	13.8	16.8	116
Solder (60% lead, 40% tin)	9280	23.7	37	-	7.28	43.6
Concrete	2400	30	40 (compressive)			0.8
Concrete (steel reinforced)						0.8
Timber (parallel to grain)		12	105			0.16
Polypropylene	1240	4	19.7 – 80	50		0.13
Polycarbonate	1200	2.3	70			0.19
ABS plastics		2.3	40	48.3		2.34
Nylon	1160	2 – 4	75	45		
Acrylic	1190	3.2	70	73.7		0.19
Glass	2500	69		3600		1.05
Diamond	3520	1000		50 000		2320
Gold	19 320	82	220	40	44.6	318
Ice	931	9.17.5@-5°C		85		2.25@-5°C
Pure water	1000					
Sea water	1022					
Petrol	740					0.15
Crude oil	800					0.15

\* Unless noted as compressive strength.

## Basic formulae (Mechanical) 1

Parameter	Formula	Terms
Mechanical Advantage [MA]	$MA = \frac{F_{load}}{F_{effort}}$	$F_{load}$ is the output force $F_{effort}$ is the input force
Velocity Ratio [VR]	$VR = \frac{d_{effort}}{d_{load}}$	$d_{effort}$ is the distance moved by the effort $d_{load}$ is the distance moved by the load
Velocity ratios in drive trains (for gear or pulley train) [VR]	$VR = \frac{F_1 F_2 F_3}{D_1 D_2 D_3}$	$F_{1,2 \text{ and } 3}$ are the followers $D_{1,2 \text{ and } 3}$ are the drivers (measured via number of teeth on gears or by pulley diameters)
Torque [ $\tau$ ]	$\tau = Fr$	$F$ is the force $r$ is the radius
Moment of a force [ $M$ ]	$M = Fd$	$F$ is the force $d$ is the perpendicular distance
Stress [ $\sigma$ ] or Pressure [ $p$ ]	$\sigma (p) = \frac{F}{A}$	$F$ is the force $A$ is the area
Strain [ $\varepsilon$ ]	$\varepsilon = \frac{\Delta L}{L}$	$\Delta L$ is the change in length $L$ is the original length
Young's (Elastic) modulus [ $E$ ]	$E = \frac{\sigma}{\varepsilon}$	$\sigma$ is the stress $\varepsilon$ is the strain
Young's (Elastic) modulus [ $E$ ] expanded formula	$E = \frac{FL}{A\Delta L}$	$F$ is the force $A$ is the area $\Delta L$ is the change in length $L$ is the original length
Factor of Safety [FS]	$FS = \frac{\sigma_{UTS}}{\sigma_{safeworking}}$	$\sigma_{UTS}$ is the ultimate tensile stress $\sigma_{safeworking}$ is the safe working stress
Acceleration [ $a$ ]	$a = \frac{v - u}{t}$	$v$ is the final velocity $u$ is the initial velocity $t$ is the time
Velocity [ $v$ ]	$v^2 = u^2 + 2as$	$u$ is the initial velocity $a$ is the acceleration $s$ is the distance
Distance [ $s$ ]	$s = ut + \frac{1}{2}at^2$	$u$ is the initial velocity $t$ is the time $a$ is the acceleration
Force [ $F$ ]	$F = ma$	$m$ is the mass $a$ is the acceleration
Equilibrium conditions	$\sum M = 0$ $\sum F_y = 0$ $\sum F_x = 0$	$\Sigma$ is the 'sum of' $M$ are the moments $F_y$ are the vertical force components $F_x$ are the horizontal force components
Equilibrium conditions (expanded)	$\Sigma CWM = \Sigma ACWM$ $\Sigma F(up) = \Sigma F(down)$ $\Sigma F(left) = \Sigma F(right)$	$\Sigma$ is the 'sum of' $CWM$ are clockwise moments $ACWM$ are anticlockwise moments

## Basic formulae (Mechanical) 2

Parameter	Formula	Terms
Work [W]	$W = Fs$	$F$ is the force $s$ is the distance moved
Power [P]	$P = \frac{Fs}{t} = Fv$	$F$ is the force $s$ is the distance $t$ is the time taken $v$ is the average velocity
Energy [E]	$E = Pt$	$t$ is the time taken $P$ is the power
Potential energy [E <sub>p</sub> ]	$E_p = mgh$	$m$ is the mass $g$ is the acceleration due to gravity $h$ is the height
Kinetic energy [E <sub>k</sub> ]	$E_k = \frac{1}{2}mv^2$	$m$ is the mass $v$ is the velocity
Potential and kinetic energy conversion	$\Delta E_p = \Delta E_k$	$\Delta$ is the 'change in'
Efficiency [ $\eta$ ] %	$\eta\% = \frac{\text{Work done in moving load}}{\text{Work done by the effort}} \times 100$	Work done in moving load is the output Work done by the effort is the input
Compound gear or pulley system [RPM]	$\text{output RPM} = \frac{\text{input RPM}}{VR}$	$VR$ is the velocity ratio $RPM$ is the revolutions per minute
Linear velocity of a gear or pulley system [v]	$v = \frac{(RPM)(2\pi r)}{60} = \frac{s}{t}$	$r$ is the radius of the gear or pulley $s$ is the distance travelled $t$ is the time taken
Distance around a winch drum [s]	$s = 2\pi r$	$r$ is the radius of the drum

## Selected SI units

Derived quantity	SI unit			
	Name	Symbol	Expression in terms of other SI units	Expression in terms of SI base units
force	newton	N	–	m kg s <sup>-2</sup>
pressure, stress	pascal	Pa	N m <sup>-2</sup>	m <sup>-1</sup> kg s <sup>-2</sup>
energy, work, quantity of heat	joule	J	N m	m <sup>2</sup> kg s <sup>-2</sup>
power, radiant flux	watt	W	–	m <sup>2</sup> kg s <sup>-3</sup>

## Common constants

Item	Symbol	Value
Acceleration due to gravity	$g$	9.80 m s <sup>-2</sup>

Second moment of area

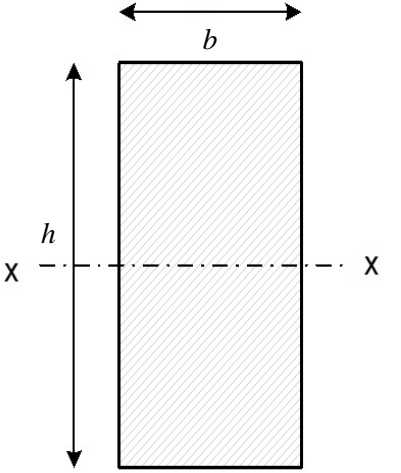
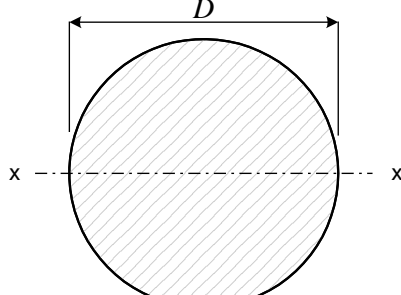
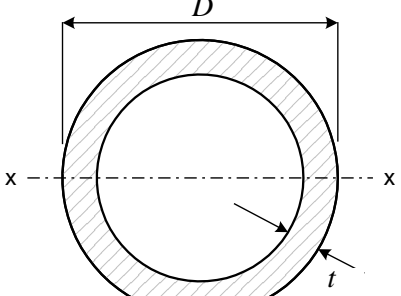
Shape	Dimensions	Second moment of area about centroidal axis
Rectangle solid section (vertical)		$I_{xx} = \frac{bh^3}{12}$
Circular solid section		$I_{xx} = \frac{\pi D^4}{64}$
Circular tube section		$I_{xx} = \frac{\pi(D_o^4 - D_i^4)}{64}$ <p> <math>D_o</math> = cylinder outside diameter  <math>D_i</math> = cylinder inside diameter                     </p>

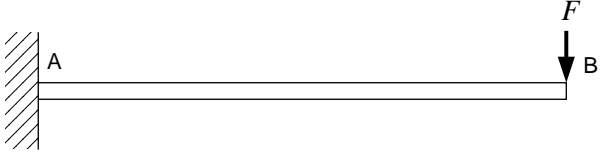
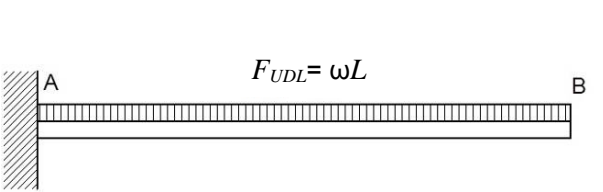
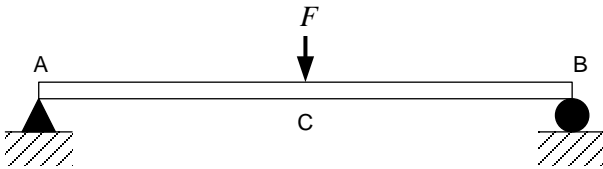
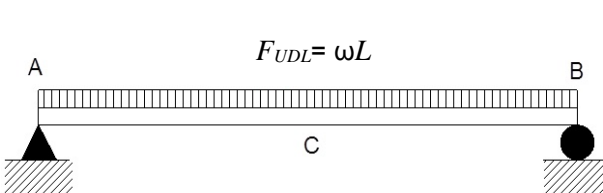

Simple beams

Beam configuration	Maximum bending moment	Maximum deflection (y)
	$BM_{\max} = FL \text{ at } A$ <p>Here <math>F</math> is the single vertical point load.</p>	$y = \frac{FL^3}{3EI_{xx}} \text{ at } B$ <p>Here <math>F</math> is the single vertical point load.</p>
	$BM_{\max} = \frac{F_{UDL}L}{2} \text{ at } A$ <p>Here <math>F_{UDL} = \omega L</math> which is the load per unit length (<math>\omega</math>) times the length of the beam (<math>L</math>)</p>	$y = \frac{F_{UDL}L^3}{8EI_{xx}} \text{ at } B$ <p>Here <math>F_{UDL} = \omega L</math> which is the load per unit length (<math>\omega</math>) times the length of the beam (<math>L</math>)</p>
	$BM_{\max} = \frac{FL}{4} \text{ at } C$ <p>Here <math>F</math> is the single vertical point load.</p>	$y = \frac{FL^3}{48EI_{xx}} \text{ at } C$ <p>Here <math>F</math> is the single vertical point load.</p>
	$BM_{\max} = \frac{F_{UDL}L}{8} \text{ at } C$ <p>Here <math>F_{UDL} = \omega L</math> which is the load per unit length (<math>\omega</math>) times the length of the beam (<math>L</math>)</p>	$Y = \frac{5F_{UDL}L^3}{384EI_{xx}} \text{ at } C$ <p>Here <math>F_{UDL} = \omega L</math> which is the load per unit length (<math>\omega</math>) times the length of the beam (<math>L</math>)</p>

Terms:

- $L$  Length of beam between supports
- $\omega$  A uniformly distributed load per unit length
- $F_{UDL}$  The product of the UDL's applied load/unit length ( $\omega$ ) and the length of the beam ( $L$ )
- $F$  An applied vertical point load
- $E$  The elastic (Young's) modulus of the material of the beam
- $I_{xx}$  The second moment of area of the beam section
- $A$  The left hand end of the beam
- $B$  The right hand end of the beam
- $C$  The mid-point of the beam

## Selected SI units

Quantity	Unit	Abbreviation	Symbol	Expression in terms of other SI units
Voltage	volt	V	<i>V</i>	W A <sup>-1</sup>
Current	ampere	A	<i>I</i>	W V <sup>-1</sup>
Resistance	ohm	Ω	<i>R</i>	V A <sup>-1</sup>
Charge	coulomb	C	<i>Q</i>	A s
Capacitance	farad	F	<i>C</i>	A s V <sup>-1</sup>
Power	watt	W	<i>P</i>	J s <sup>-1</sup>
Frequency	hertz	Hz	<i>f</i>	s <sup>-1</sup>

## Prefixes

Prefix	Abbreviation	Multiplier
tera	T	10 <sup>12</sup> = 1 000 000 000 000
giga	G	10 <sup>9</sup> = 1 000 000 000
mega	M	10 <sup>6</sup> = 1000 000
kilo	k	10 <sup>3</sup> = 1000
(none)	(none)	10 <sup>0</sup> = 1
milli	m	10 <sup>-3</sup> = 0.001
micro	μ	10 <sup>-6</sup> = 0.000 001
nano	n	10 <sup>-9</sup> = 0.000 000 001
pico	p	10 <sup>-12</sup> = 0.000 000 000 001

Standard symbols

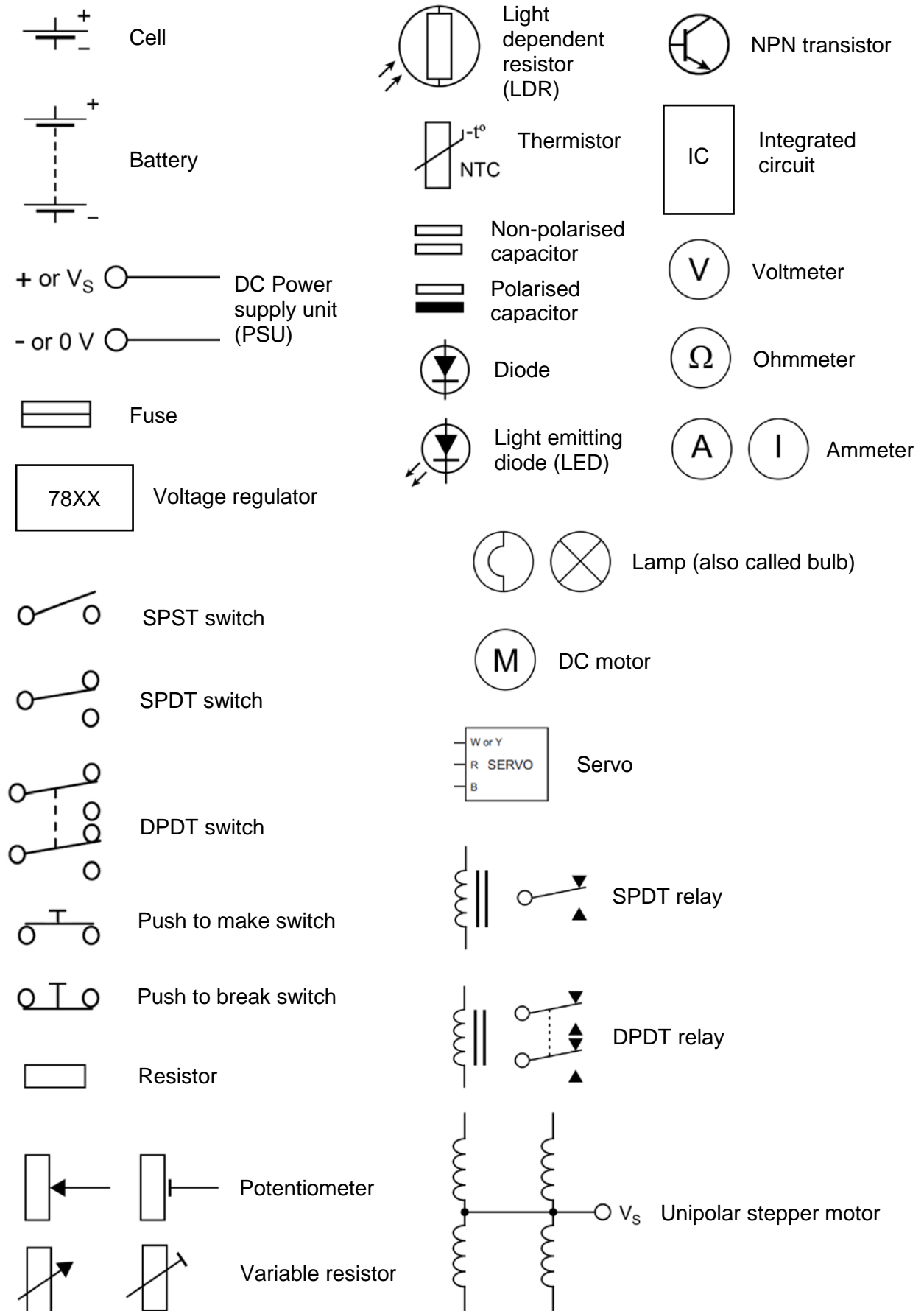

Resistor colour codes

band colour	1st band	2nd band	multiplier
Black		0	1
Brown	1	1	10
Red	2	2	100
Orange	3	3	1000
Yellow	4	4	10 000
Green	5	5	100 000
Blue	6	6	1 000 000
Violet	7	7	
Grey	8	8	
White	9	9	

tolerance band	
Brown	± 1%
Red	± 2%
Gold	± 5%
Silver	± 10%

E12 Preferred values: 10, 12, 15, 18, 22, 27, 33, 39, 47, 56, 68, 82

Example: 4 band colour code

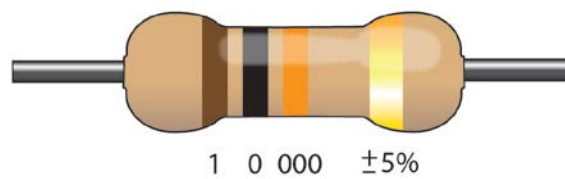

Electrical formula wheel

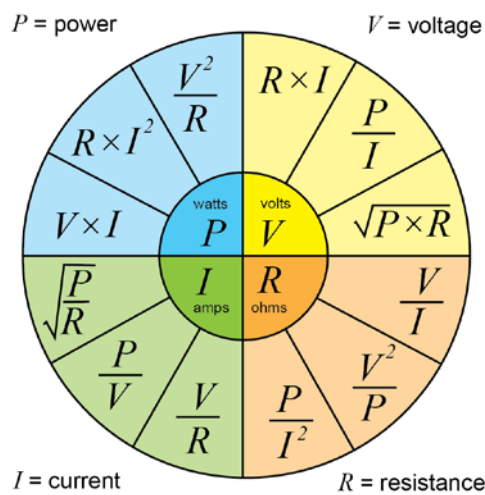

## Basic formulae (Mechatronics) 1

Parameter	Formula	Terms
Ohm's law	$V = IR$	$V$ is the voltage $I$ is the current $R$ is the resistance
Power law	$P = VI = I^2R = \frac{V^2}{R}$	$P$ is the power $I$ is the current $V$ is the voltage $R$ is the resistance
Electrical energy [ $E_e$ ]	$E_e = VIt$	$V$ is the voltage $I$ is the current $t$ is the time
Resistors in series	$R_t = R_1 + R_2 + \dots$	$R_t$ is the total resistance $R_1, R_2, \dots$ are the individual resistances
Resistors in parallel	$\frac{1}{R_t} = \frac{1}{R_1} + \frac{1}{R_2} + \dots$	$R_t$ is the total resistance $R_1, R_2, \dots$ are the individual resistances
Kirchhoff's first law	$\sum I = 0$	The sum of currents flowing toward that point is equal to the sum of currents flowing away from that point
Kirchhoff's second law	$\sum \Delta V = 0$	The directed sum of the electrical potential differences around a closed loop in a circuit must be zero
Capacitors in parallel	$C = C_1 + C_2 + \dots$	$C$ is the total capacitance $C_1, C_2, \dots$ are the individual capacitances
Capacitors in series	$\frac{1}{C} = \frac{1}{C_1} + \frac{1}{C_2} + \dots$	$C$ is the total capacitance $C_1, C_2, \dots$ are the individual capacitances
Voltage dividers	$V_{cc} = V_1 + V_2$ $V_1 = V_{cc} \frac{R_1}{R_1 + R_2}$ $V_2 = V_{cc} \frac{R_2}{R_1 + R_2}$	$V_{cc}$ is the total voltage across the resistor pair $V_1$ is the voltage across resistor $R_1$ $V_2$ is the voltage across resistor $R_2$
LED in series with a resistor	$R = \frac{(V_{cc} - V_{LED})}{I_{LED}}$	$V_{cc}$ is the total applied voltage $V_{LED}$ is the voltage across the LED $I_{LED}$ is the current through the LED $R$ is the series resistor
Transistor current gain	$h_{FE} = \frac{I_C}{I_B}$	$I_C$ is the collector current $I_B$ is the base current

## Basic formulae (Mechatronics) 2

Parameter	Formula	Terms
Mechanical advantage ( $MA$ )	$MA = \frac{\text{load}}{\text{effort}}$	
Velocity ratio ( $VR$ )	$VR = \frac{\text{distance moved by effort}}{\text{distance moved by load}}$	
Pulley belt ratio	$VR = \frac{\text{Ø follower pulley}}{\text{Ø driver pulley}}$	
Chain and sprocket ratio	$VR = \frac{n^\circ \text{ teeth follower gear}}{n^\circ \text{ teeth driver gear}}$	
Gear ratio	$VR = \frac{n^\circ \text{ teeth follower gear}}{n^\circ \text{ teeth driver gear}}$	
Compound gear ratio	$VR_T = VR_1 \times VR_2 \times \dots$	$VR_T$ is the total velocity ratio $VR_1, VR_2, \dots$ are the individual velocity ratios
Worm and worm wheel ratio	$VR = \frac{n^\circ \text{ teeth worm wheel}}{1}$	
Rack and pinion	$distance = \frac{n^\circ \text{ teeth pinion} \times n^\circ \text{ revolutions}}{n^\circ \text{ teeth per metre rack}}$	
Speed, velocity	$velocity = \frac{distance}{time} = \frac{(rpm)(2\pi r)}{60}$	
	$output \text{ rpm} = \frac{input \text{ rpm}}{VR}$	$VR$ is the velocity ratio $rpm$ is the revolutions per minute

## SI units

Quantity	SI unit	
	Name	Symbol
distance	metre	m
time	second	s
speed, velocity	metre per second	$\text{m s}^{-1}$

Diode model	Formula	Terms/diagrams
On	$V_D = V_{D,on}$ (or $V_F$ ) <b>Check:</b> $I_D > 0$	
Off	$I_D = 0$ A <b>Check:</b> $V_D < V_{D,on}$ (or $V_F$ )	

Transistor model (NPN BJT)	Formula	Terms/diagrams
Cut-off	$I_B = I_C = 0$ A <b>Check:</b> $V_{BE} < 0.7$ V	
Saturation	$V_{BE} = 0.7$ V $V_{CE} = 0$ V <b>Check:</b> $I_B > 0$ A $\frac{I_C}{I_B} < \beta$ (or $h_{FE}$ )	
Forward-active	$V_{BE} = 0.7$ V $I_C = \beta \times I_B$ <b>Check:</b> $I_B > 0$ A $V_{CE} > 0$ V	
Transistor current gain	Gain or $\beta$ or $h_{FE} = \frac{I_C}{I_B}$	

Logic symbols with truth tables and Boolean expressions

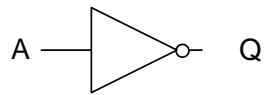

NOT Gate  
Output =  $\bar{A}$

A	Q
0	1
1	0

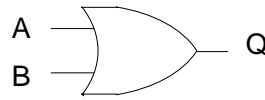

OR Gate  
Output =  $A + B$

A	B	Q
0	0	0
1	0	1
0	1	1
1	1	1

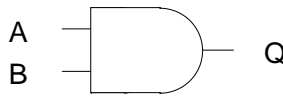

AND Gate  
Output =  $A \cdot B$

A	B	Q
0	0	0
1	0	0
0	1	0
1	1	1

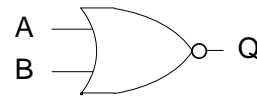

NOR Gate  
Output =  $\overline{A + B}$

A	B	Q
0	0	1
1	0	0
0	1	0
1	1	0

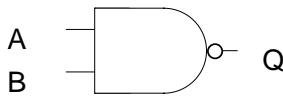

NAND Gate  
Output =  $\overline{A \cdot B}$

A	B	Q
0	0	1
1	0	1
0	1	1
1	1	0

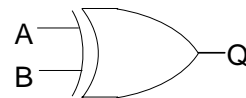

XOR Gate  
Output =  $A \oplus B$

A	B	Q
0	0	0
1	0	1
0	1	1
1	1	0

Flow chart symbols

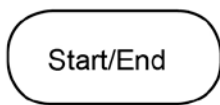

Start or end of a program or subroutine

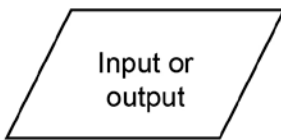

Input from a device, switch or keyboard, or output to a device

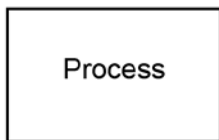

A step in the computational process

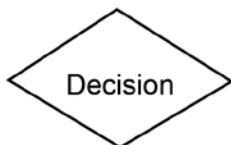

A decision point with a Yes/No result



Flow of computation

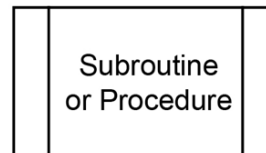

A predefined process

End of Data Booklet



**This page has been left blank intentionally**

**This page has been left blank intentionally**

**This page has been left blank intentionally**

## ACKNOWLEDGEMENTS

**Electrical relationships:** Electrical formula wheel. Retrieved January, 2010,  
from [www.sengpielaudio.com/calculatorohm.htm#top](http://www.sengpielaudio.com/calculatorohm.htm#top).